

SAF系列带锁液压空气滤清器（新型）

订购码

SAF	-	50	-	A	-	40	/	L =	65
系列名称		口径		油滤网		空气过滤精度		安装方式	
带锁液压空气滤清器		50, 65		A: 带加油滤网 省略: 不带加油滤网		40μm		L=65;85;135,带安装法兰 省略: 带安装法兰 65A仅配L=65	

技术参数及安装尺寸

型号	口径	H	D	D1	D2	d	L1	螺栓(均布)
SAF-50A	50	199	φ 56	φ 90	φ 100	φ 67	2.5	6-M4X16
SAF-65A	65	235	φ 68	φ 105	φ 123	φ 69	2	4-M8X16

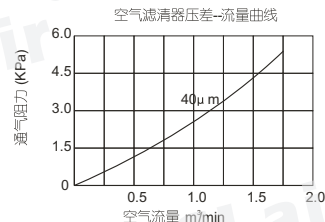
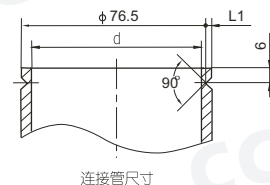
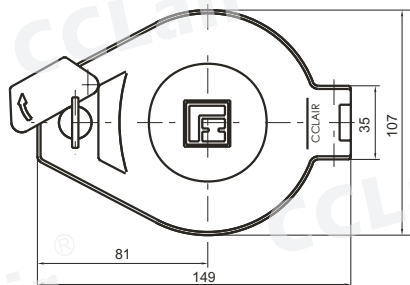
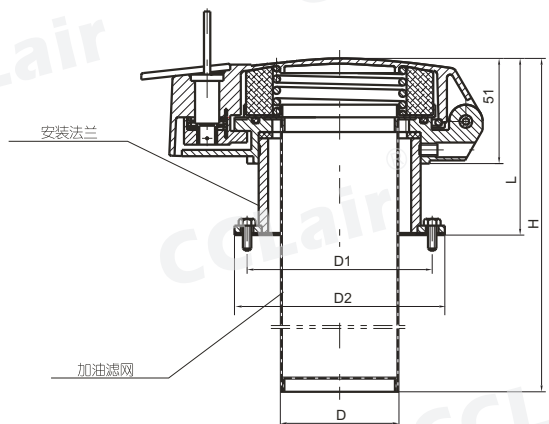

AF-22、AF-35型空气滤清器（新型）

外形尺寸



AF-22

AF-35

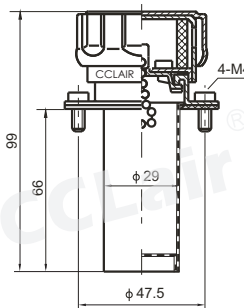
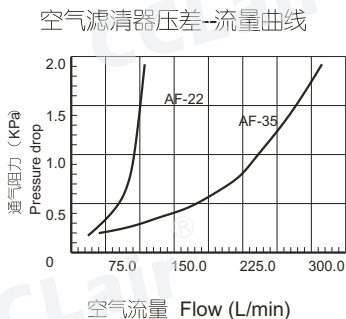

AF-22

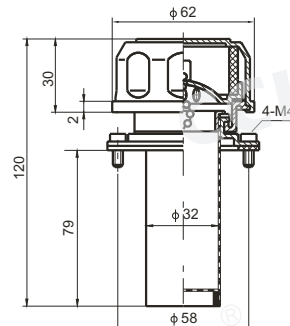

AF-35